



PLAYA DEL SOL

PROJECT BRIEF



PLAYA DEL SOL

LIFE IN A DIFFERENT LIGHT

Welcome to Playa Del Sol, Ellington's exclusive development on the iconic shores of Al Marjan Island in Ras Al Khaimah. Playa Del Sol redefines island living, perfecting every detail for a lifestyle that feels uniquely yours. Embrace a vibrant way of life, where each moment is filled with beauty, serenity, and the rhythm of island living.

A UNIQUE REFLECTION OF ISLAND LIFE



Playa Del Sol stands as a bold architectural statement, designed to immerse residents in stunning views of the Arabian Gulf while offering unparalleled proximity to the prestigious Wynn Resort.

AN EMBODIMENT OF COASTAL ELEGANCE

AL JAZEERA
AL HAMRA

HAYAT ISLAND

RAK CENTRAL

AL HAMRA
VILLAGE

WYNN
RESORT

ELLINGTON
VIEWS

BEACH
ACCESS

BEACH
ACCESS

BEACH
ACCESS

BEACH
ACCESS

FISHING BOULEVARD

AL MARJAN ISLAND BOULEVARD

AL MARJAN ISLAND BOULEVARD



DRIVING DISTANCES

- 04 MINS — WYNN RESORT
- 08 MINS — AL HAMRA MALL
- 09 MINS — RAK CENTRAL
- 10 MINS — AL HAMRA GOLF CLUB
- 12 MINS — ROYAL YACHT CLUB OF RAS AL KHAIMAH
- 12 MINS — RAK TRACK
- 25 MINS — RAK MALL
- 27 MINS — AL QAWASIM CORNICHE & RAK EYE
- 31 MINS — RAK INTERNATIONAL AIRPORT
- 33 MINS — RAK ECONOMIC ZONE
- 42 MINS — JEBEL JAIS ENTRANCE
- 45 MINS — SHARJAH INTERNATIONAL AIRPORT
- 60 MINS — DUBAI INTERNATIONAL AIRPORT

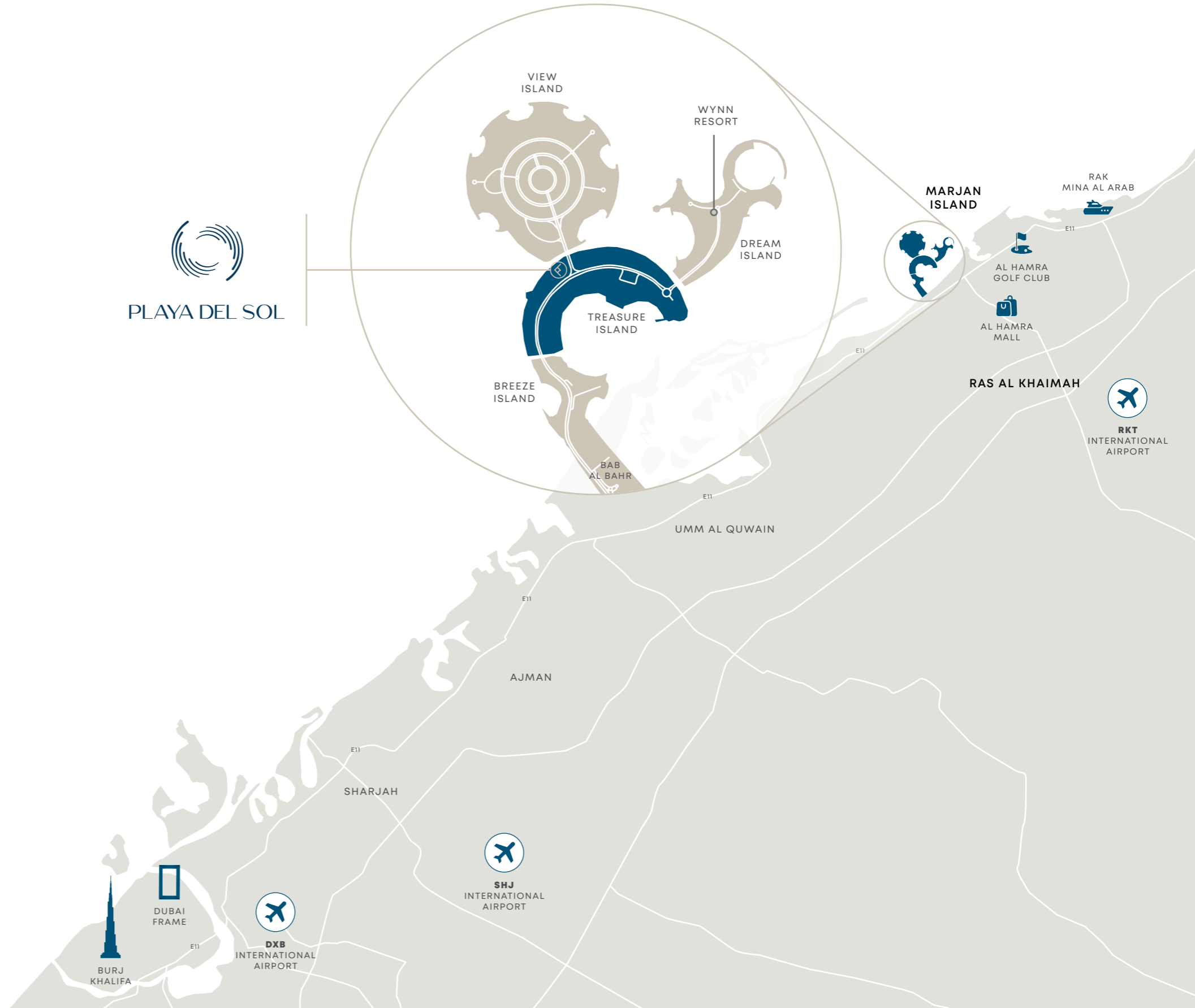

SUN & VIEWS ANALYSIS

SUNSET



PLAYA DEL SOL



SUMMER

WINTER



SUNRISE



AN UNPARALLELED ISLAND LIVING



ARCHITECTURAL CONCEPT

01

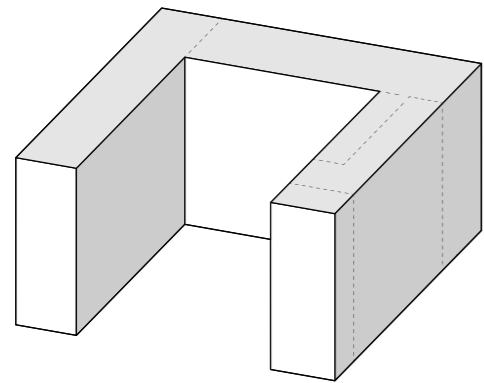

02

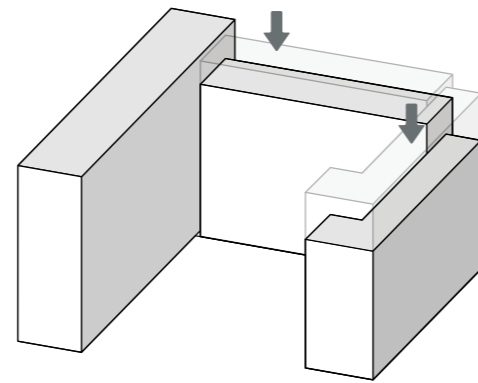

03

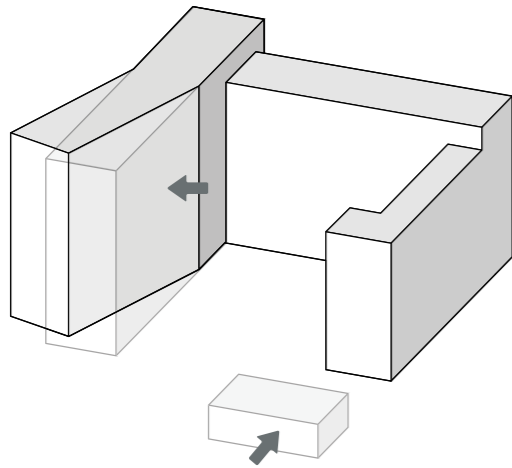

04

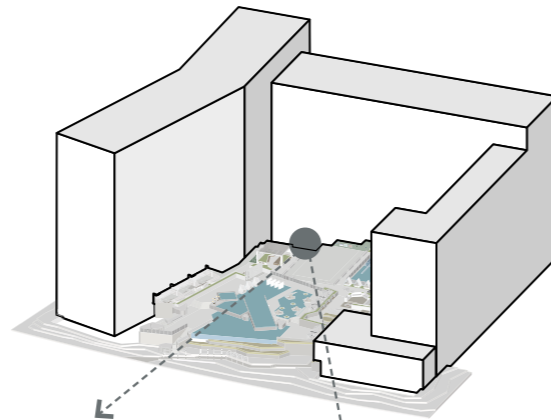

Maximising key views,
value to apartments and
public space orientation
to the site and context.

05



A retreat where wellness, fitness, and
social indulgence come together in
perfect harmony.

ARCHITECTURAL SECTIONS

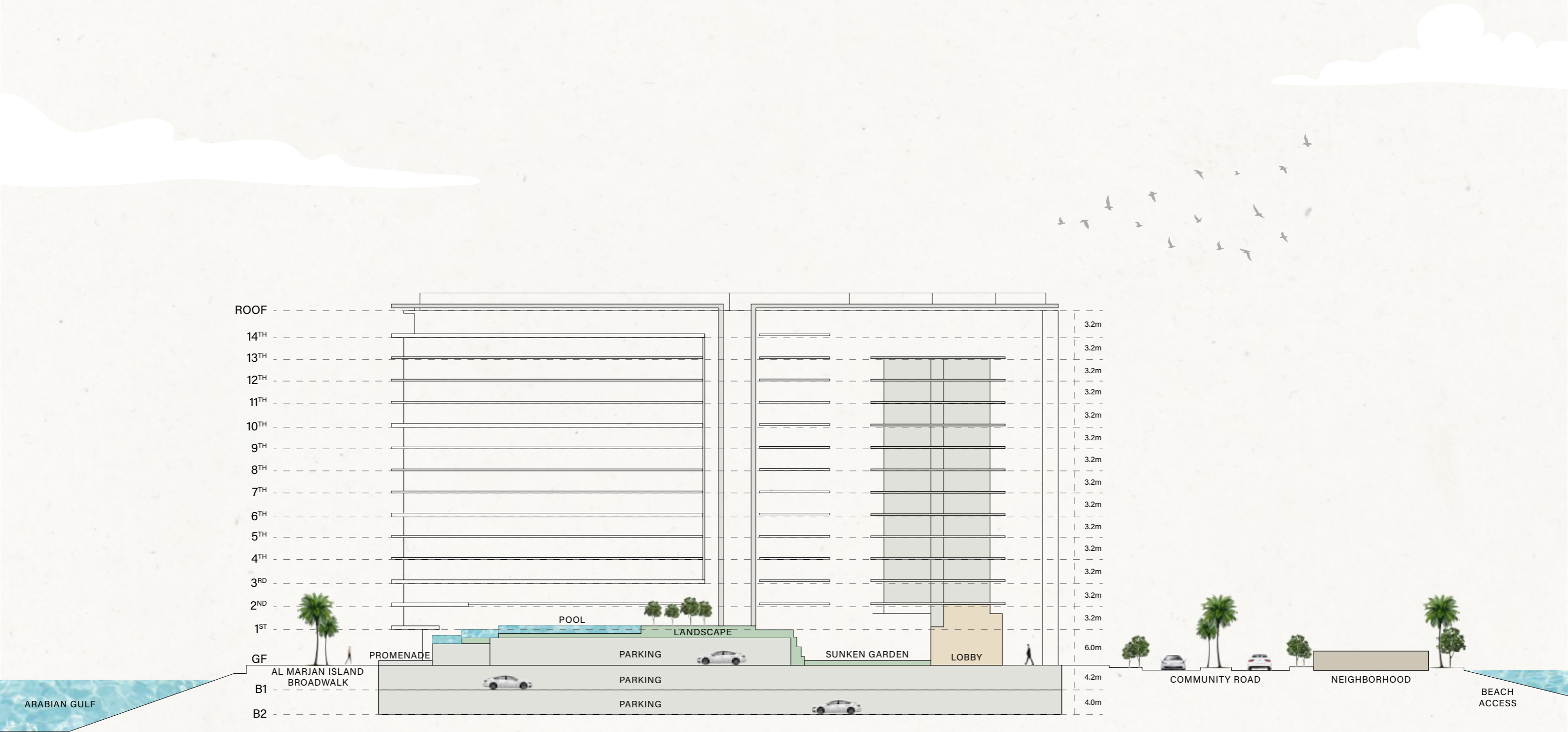

BUILDING CONFIGURATION



2B + GF + 14R

BREATHTAKING HORIZONS

360 VIEWS

Wynn Resort, Arabian Gulf,
Al Marjan Island

OWNERSHIP

Freehold

ANTICIPATED SERVICE CHARGE

AED 16 per sq.ft.

ELEVATORS

6 passenger elevators
2 service elevators

PARKING

Studio, 1 and 2 beds: 1 parking
3-bed: 2 car parking
4-bed penthouses: 3 car parking
5-bed villa: 4 car parking



UNIT SIZES AND TYPES



APARTMENTS

NUMBER OF UNITS

SIZE RANGE

STUDIOS

34 units

From 400.85 sq. ft.

1-BEDROOM APARTMENTS

274 units

From 683.62 sq. ft. to 758.86 sq. ft.

2-BEDROOM APARTMENTS

185 units

From 1,061.86 sq. ft. to 1,381.76 sq. ft.

3-BEDROOM APARTMENTS

20 units

From 1,898.00 sq. ft. to 3,778.56 sq. ft.

4-BEDROOM PENTHOUSE

2 units

From 3,459.09 sq. ft. to 3,550.37 sq. ft.

5-BEDROOM VILLA

1 unit

From 8,524.69 sq. ft.

516 TOTAL RESIDENTIAL UNITS



AMENITIES

An oasis of timeless coastal elegance, Playa Del Sol is a sanctuary designed for a balanced lifestyle of relaxation and recreation. Offering a curated experience, Playa Del Sol seamlessly merges waterfront living with world-class leisure.

AMENITIES SECTIONING

1ST FLOOR

Clubhouse
Kids Club
Gym
Yoga Studio
Changing Room + Sauna

GROUND FLOOR

Main Lobby
Wellness Spa
Squash Courts

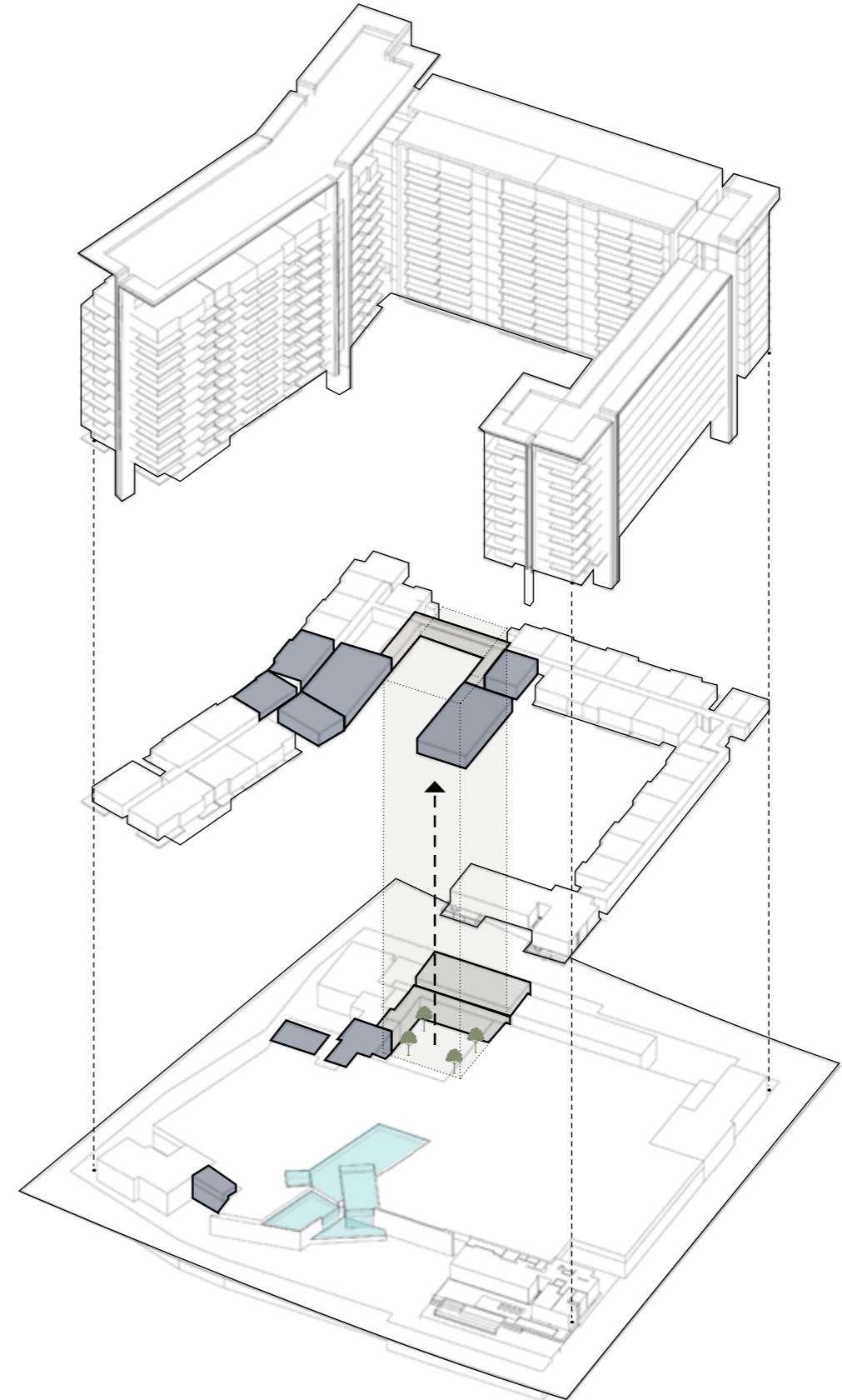



GROUND FLOOR AMENITIES

GROUND FLOOR AMENITIES PLAN

- 1 MAIN ENTRANCE/EXIT
- 2 DROP-OFF AREA
- 3 ENTRYWAY SEATING
- 4 BICYCLE PARKING
- 5 LOBBY ENTRANCE
- 6 LOBBY RECEPTION
- 7 LOBBY LOUNGE
- 8 OUTDOOR LOUNGE
- 9 SUNKEN GARDEN
- 10 SPA TERRACE
- 11 SALON AREA
- 12 SPA TREATMENT ROOM
- 13 SQUASH COURT
- 14 LIFT LOBBY
- 15 SERVICE LIFT
- 16 MOVE-IN TRUCK ZONE
- 17 EV CHARGING STATION
- 18 ACCESS TO RESIDENTS PARKING
- 19 VILLA PRIVATE ENTRANCE
- 20 ACCESS TO UPPER POOL DECK
- 21 LOWER DECK SUN LOUNGERS AREA
- 22 CASCADE WATERFALL
- 23 GARDEN BENCHES
- 24 CHANGE ROOMS
- 25 ACCESS TO BOARDWALK
- 26 ACCESS TO PRIVATE JETTY
- 27 FIRST CLASS YACHT SERVICE



GROUND FLOOR





PLAYA DEL SOL



DROP-OFF AREA AND LOBBY ENTRANCE



LOBBY RECEPTION



LOBBY LOUNGE



SUNKEN GARDEN



SALON & SPA TREATMENT ROOMS



SQUASH COURT



PLAYA DEL SOL JETTY AND
AL MARJAN ISLAND BOARDWALK

1ST FLOOR AMENITIES



1ST FLOOR AMENITIES PLAN

- 1 ADULT POOL OASIS
- 2 BAJA SHELF
- 3 POOL SPA
- 4 WATER LOUNGE
- 5 SUN LOUNGERS AREA
- 6 CABANAS
- 7 OUTDOOR SHOWER
- 8 POOL DECK ACCESS
- 9 LOUNGE PLAZA
- 10 CLUBHOUSE TERRACE
- 11 CLUBHOUSE
- 12 PANTRY
- 13 TEENS CLUBHOUSE
- 14 OUTDOOR KIDS PLAY AREA
- 15 INDOOR KIDS PLAY AREA
- 16 KIDS POOL
- 17 OUTDOOR FITNESS AREA
- 18 GARDEN TERRACE & LOUNGE
- 19 GAMES TABLE ZONE
- 20 BARBEQUE DECK WITH DINING & SEATING
- 21 ACCESS TO BOARDWALK
- 22 OUTDOOR YOGA AREA
- 23 YOGA STUDIO
- 24 FITNESS STUDIO
- 25 FEMALE CHANGE ROOM
- 26 MALE CHANGE ROOM
- 27 LIFT LOBBY





ADULT OASIS POOL



CLUBHOUSE



TEENS CLUBHOUSE



FITNESS STUDIO



YOGA STUDIO



KIDS PLAY AREA

THE RESIDENCES

Playa Del Sol embodies the tranquil beauty and dynamic spirit of its coastal environment. The residences embrace natural materials, carefully chosen to reflect the luminous qualities of sunrises and sunsets unique to this setting. The interiors prioritize a seamless connection with nature, showcasing refined craftsmanship and elegant transitions that perfectly balance aesthetics with practicality.





BALCONY VIEW



LIVING AND DINING AREA



KITCHEN



BEDROOM



BATHROOM



POWDER ROOM

SIGNATURE RESIDENCES

The signature residences at Playa Del Sol offer an unparalleled living experience, featuring penthouses, duplex apartments, and a villa that command breathtaking views of the sea. With unobstructed vantage points to the ever-changing seascape, these residences create the perfect sanctuary, where elegance seamlessly blends with the tranquility of the ocean.

VILLA DESIGN

5-BEDROOM VILLA (B + G + 1)

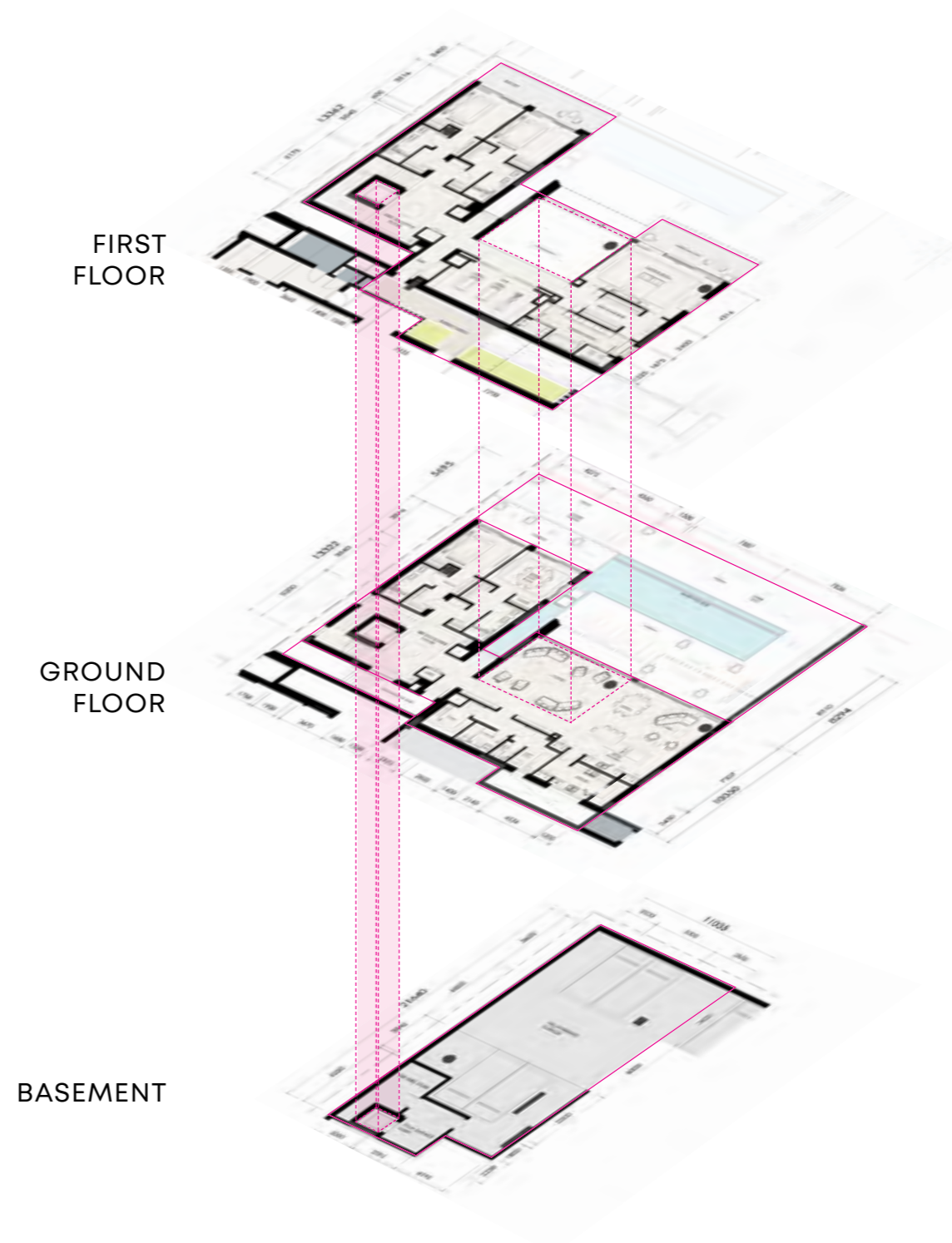

FIRST FLOOR

GROUND FLOOR

BASEMENT

DUPLEX APARTMENTS



FIRST FLOOR

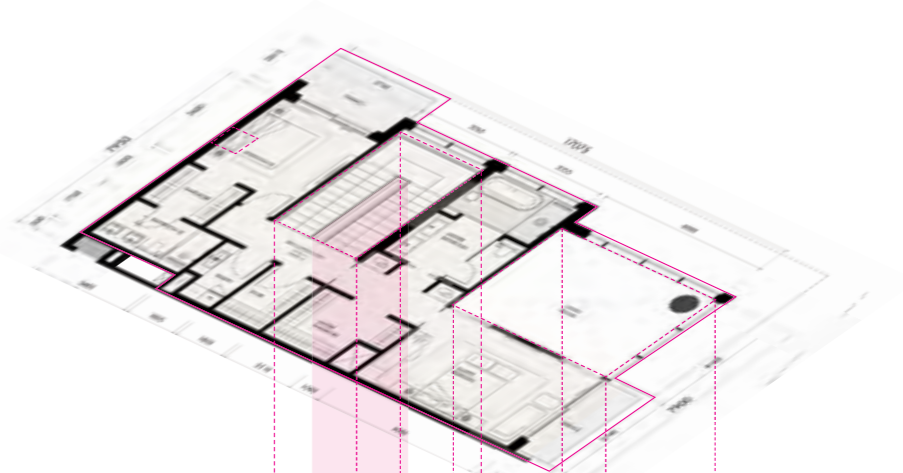

GROUND FLOOR

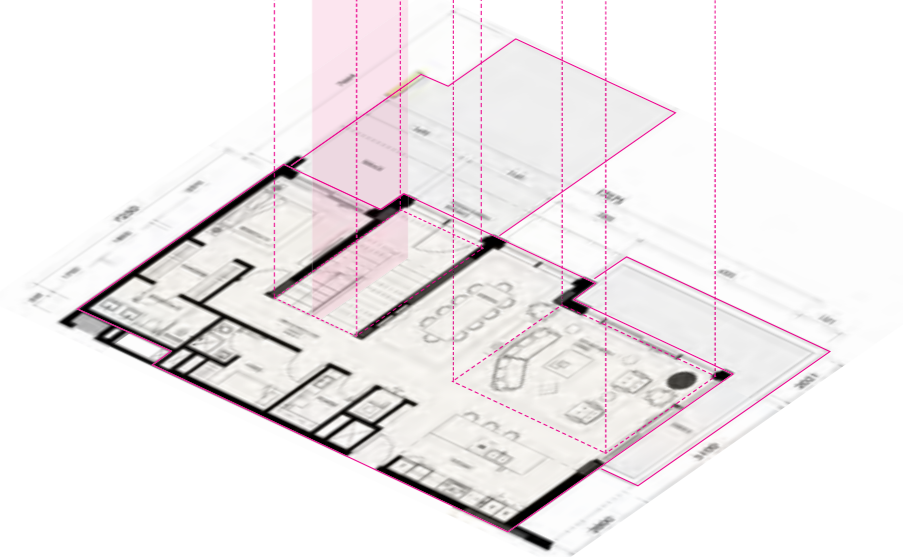

PENTHOUSES

4-BEDROOM



10TH FLOOR
TYPE A



14TH FLOOR
TYPE B

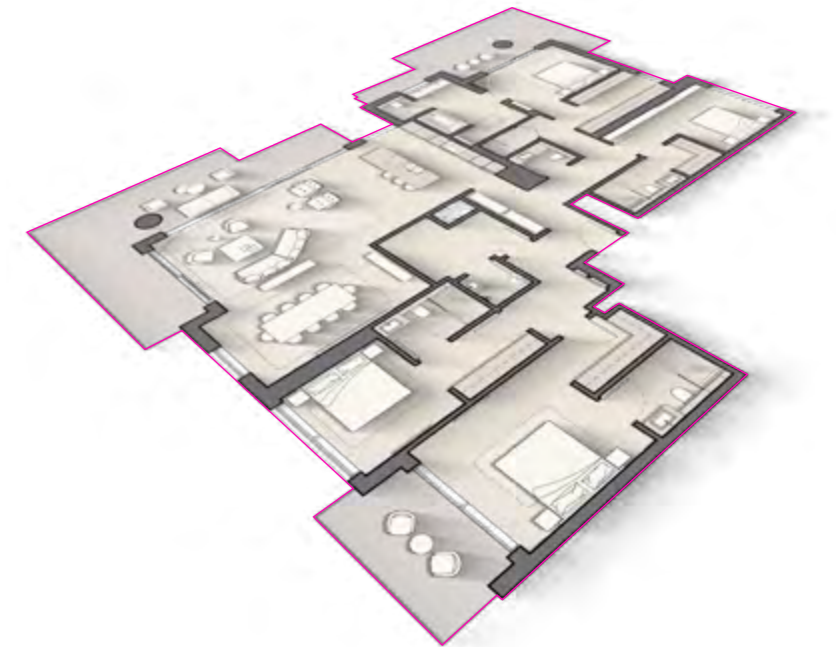

ELLINGTON

SIGNATURE VILLA WITH
A PRIVATE POOL AND GARDEN





VILLA ENTRANCE

FLOOR PLANS



GROUND FLOOR TYPICAL PLAN

VILLA
(UPPER LEVEL)



GROUND FLOOR

1ST FLOOR TYPICAL PLAN

- STUDIO
- 1-BEDROOM
- 2-BEDROOM
- 3-BEDROOM DUPLEX
(LOWER LEVEL)
- VILLA
(UPPER LEVEL)

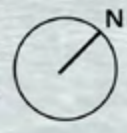

2ND FLOOR TYPICAL PLAN

-  STUDIO
-  1-BEDROOM
-  2-BEDROOM
-  3-BEDROOM
-  3-BEDROOM DUPLEX
(UPPER LEVEL)



3RD - 9TH FLOOR TYPICAL PLAN

- STUDIO
- 1-BEDROOM
- 2-BEDROOM
- 3-BEDROOM



— 3RD & 9TH FLOOR



10TH FLOOR TYPICAL PLAN

- STUDIO
- 1-BEDROOM
- 2-BEDROOM
- 3-BEDROOM
- 4-BEDROOM PENTHOUSE

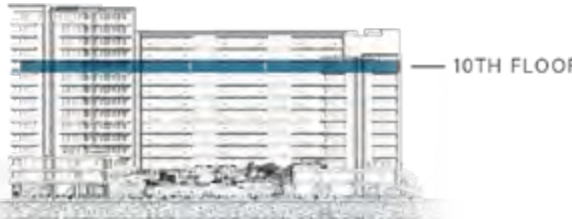

11TH - 12TH FLOOR TYPICAL PLAN

- STUDIO
- 1-BEDROOM
- 2-BEDROOM
- 3-BEDROOM



— 11TH & 12TH FLOOR

13TH FLOOR TYPICAL PLAN

- 1-BEDROOM
- 2-BEDROOM
- 3-BEDROOM



14TH FLOOR TYPICAL PLAN

- 1-BEDROOM
- 2-BEDROOM
- 4-BEDROOM PENTHOUSE



STUDIO

TYPE A



INTERNAL LIVING AREA	339.82 SQ. FT
OUTDOOR LIVING AREA	70.72 SQ. FT
TOTAL LIVING AREA	410.54 SQ. FT

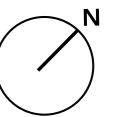
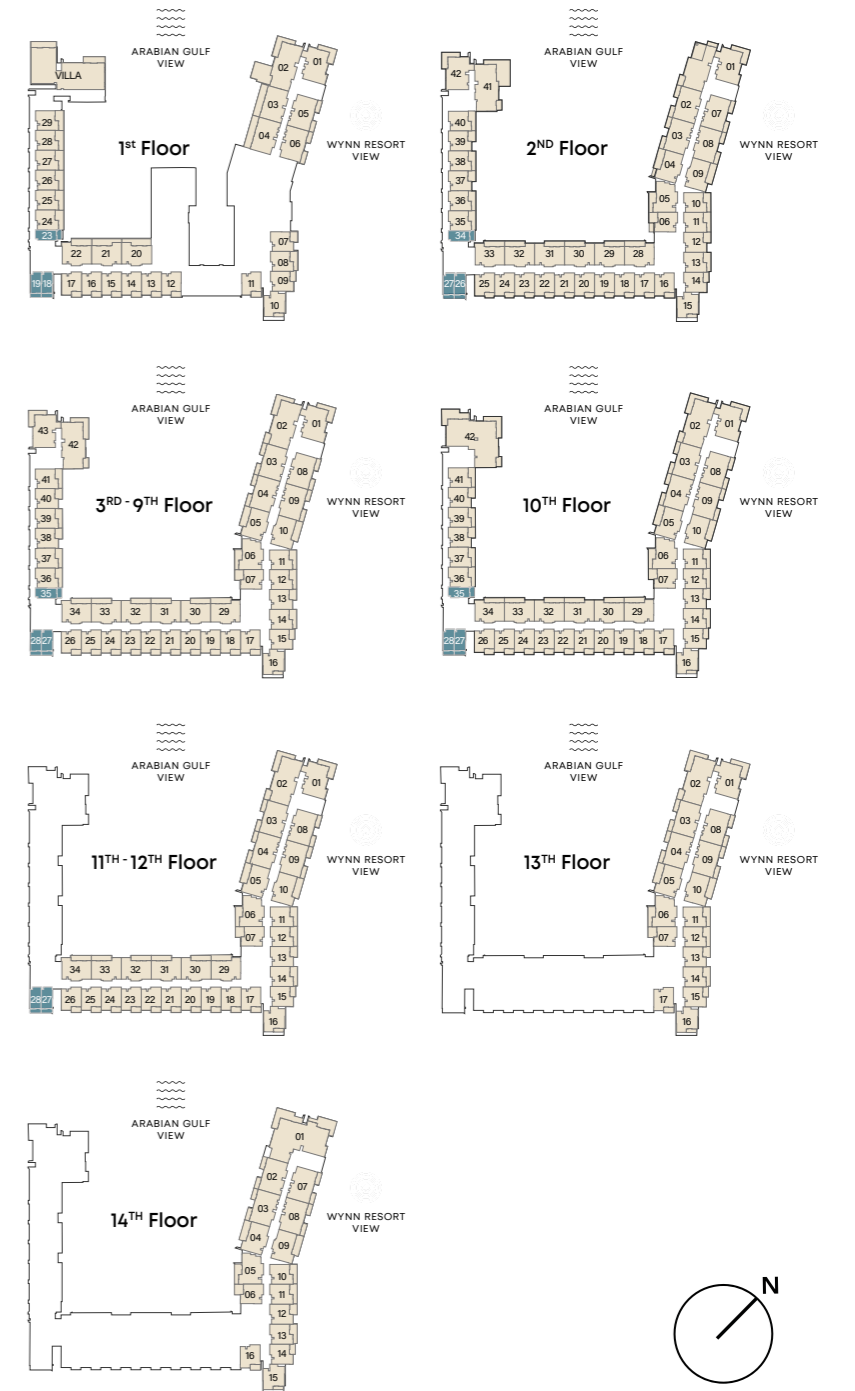

1-BEDROOM

TYPE A



INTERNAL LIVING AREA	614.73 SQ. FT
OUTDOOR LIVING AREA	87.94 SQ. FT
TOTAL LIVING AREA	702.67 SQ. FT

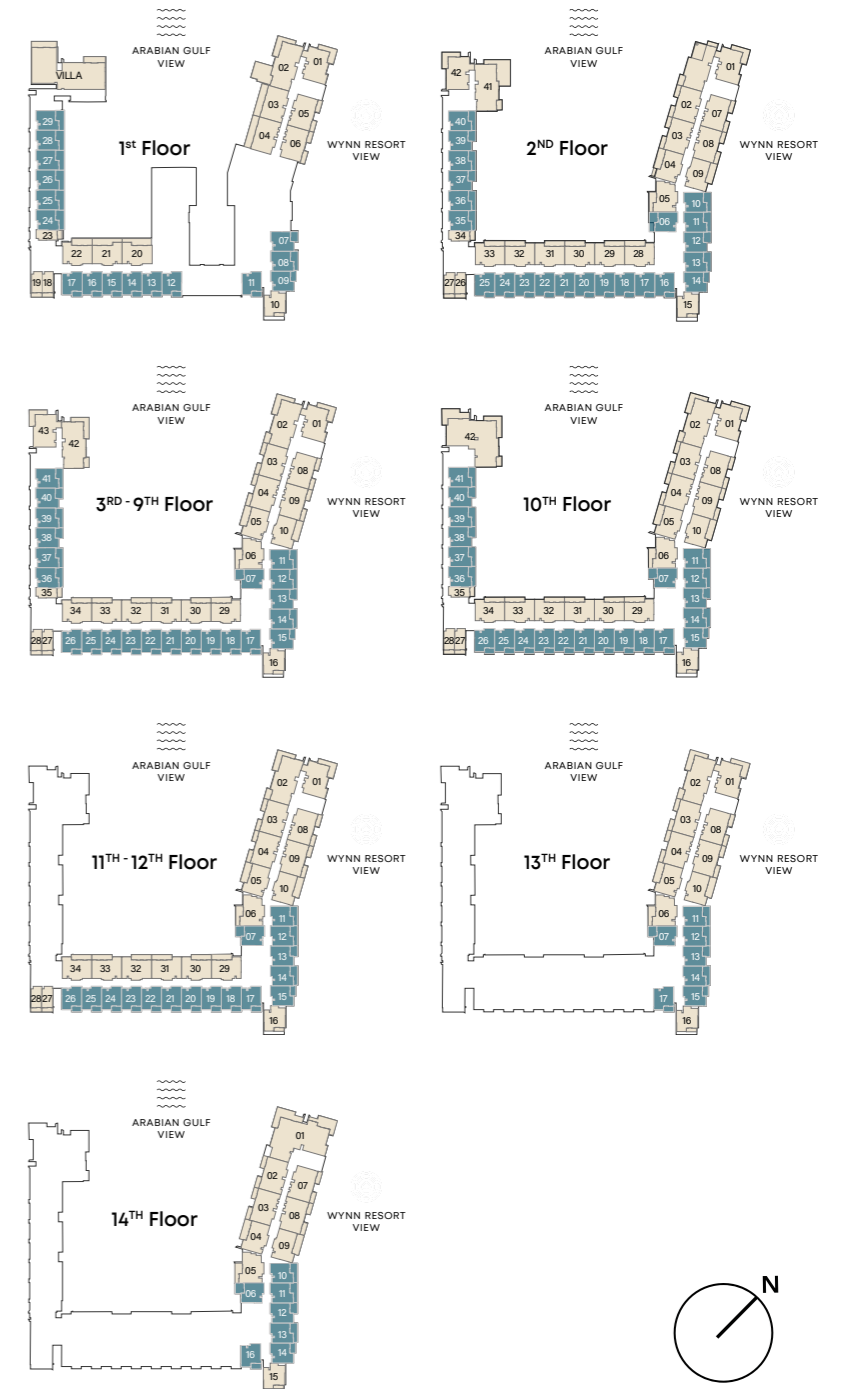

1-BEDROOM

TYPE B



INTERNAL LIVING AREA	688.24 SQ. FT
OUTDOOR LIVING AREA	70.61 SQ. FT
TOTAL LIVING AREA	758.86 SQ. FT

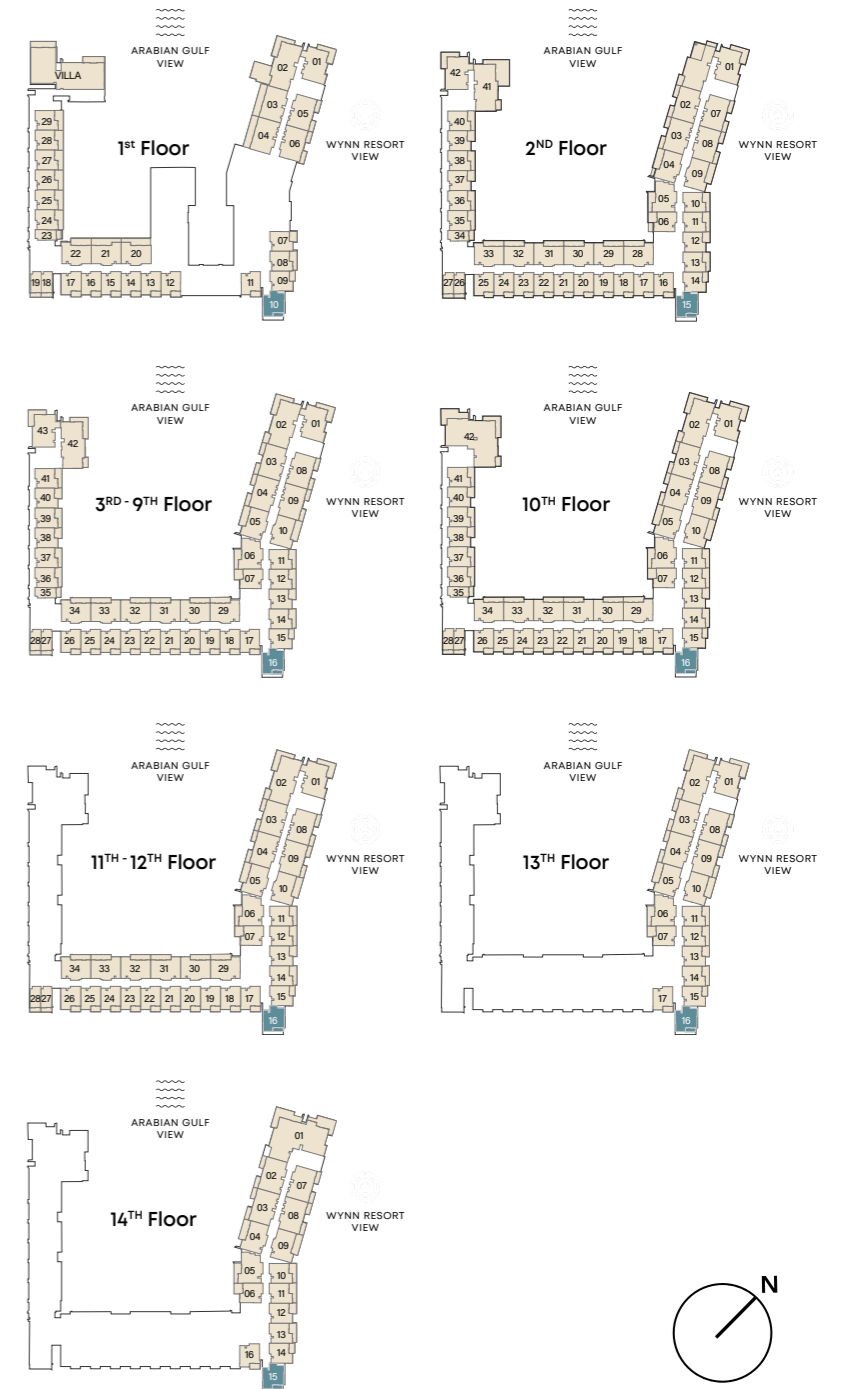

1-BEDROOM

TYPE B



INTERNAL LIVING AREA	688.24 SQ. FT
OUTDOOR LIVING AREA	70.61 SQ. FT
TOTAL LIVING AREA	758.86 SQ. FT

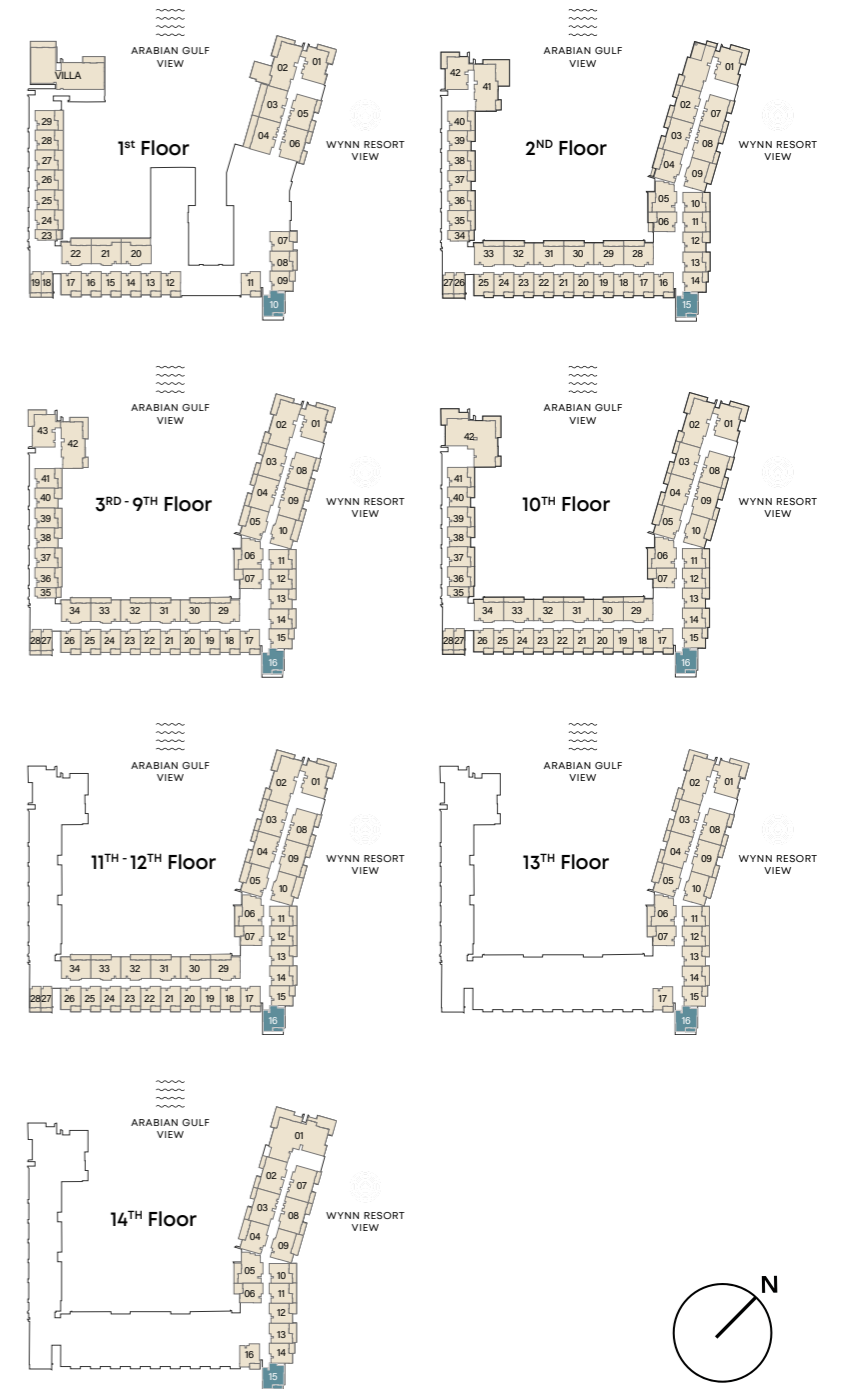

2-BEDROOM

TYPE A



INTERNAL LIVING AREA	905.68 SQ. FT
OUTDOOR LIVING AREA	168.24 SQ. FT
TOTAL LIVING AREA	1073.92 SQ. FT

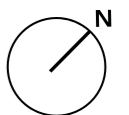
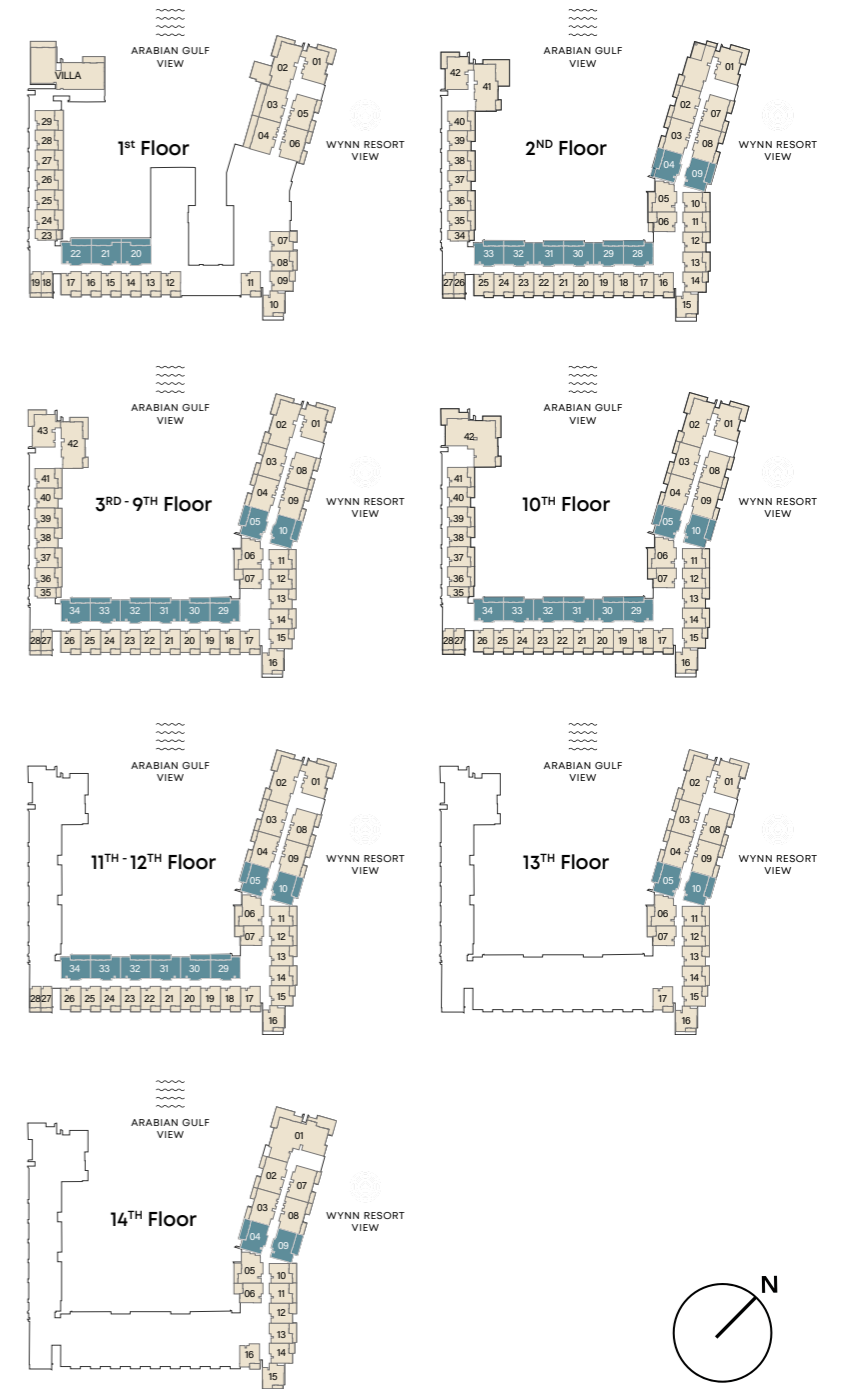

2-BEDROOM

TYPE B



INTERNAL LIVING AREA	939.47 SQ. FT
OUTDOOR LIVING AREA	180.73 SQ. FT
TOTAL LIVING AREA	1120.20 SQ. FT

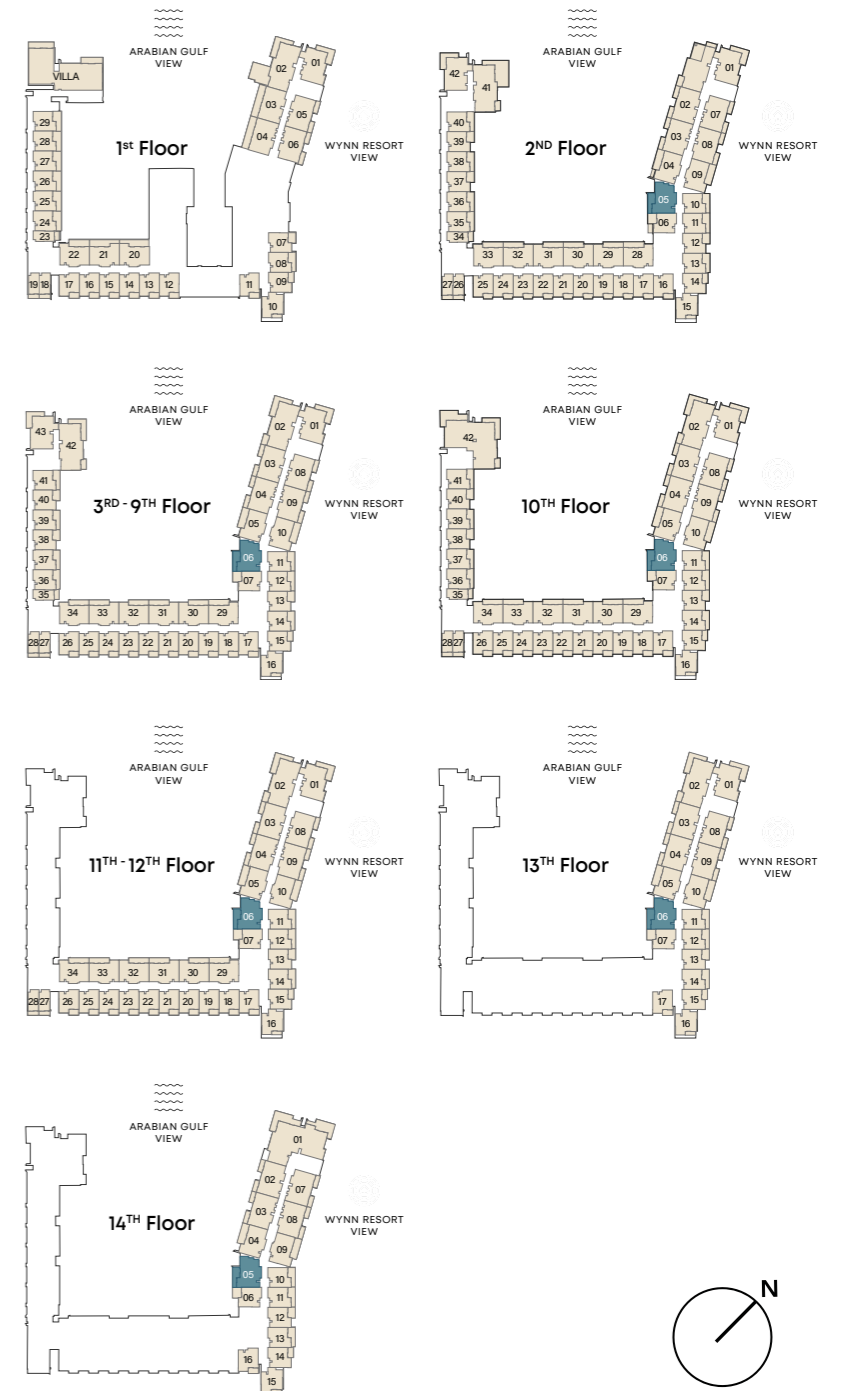

2-BEDROOM

TYPE C



INTERNAL LIVING AREA	1083.28 SQ. FT
OUTDOOR LIVING AREA	167.27 SQ. FT
TOTAL LIVING AREA	1250.55 SQ. FT

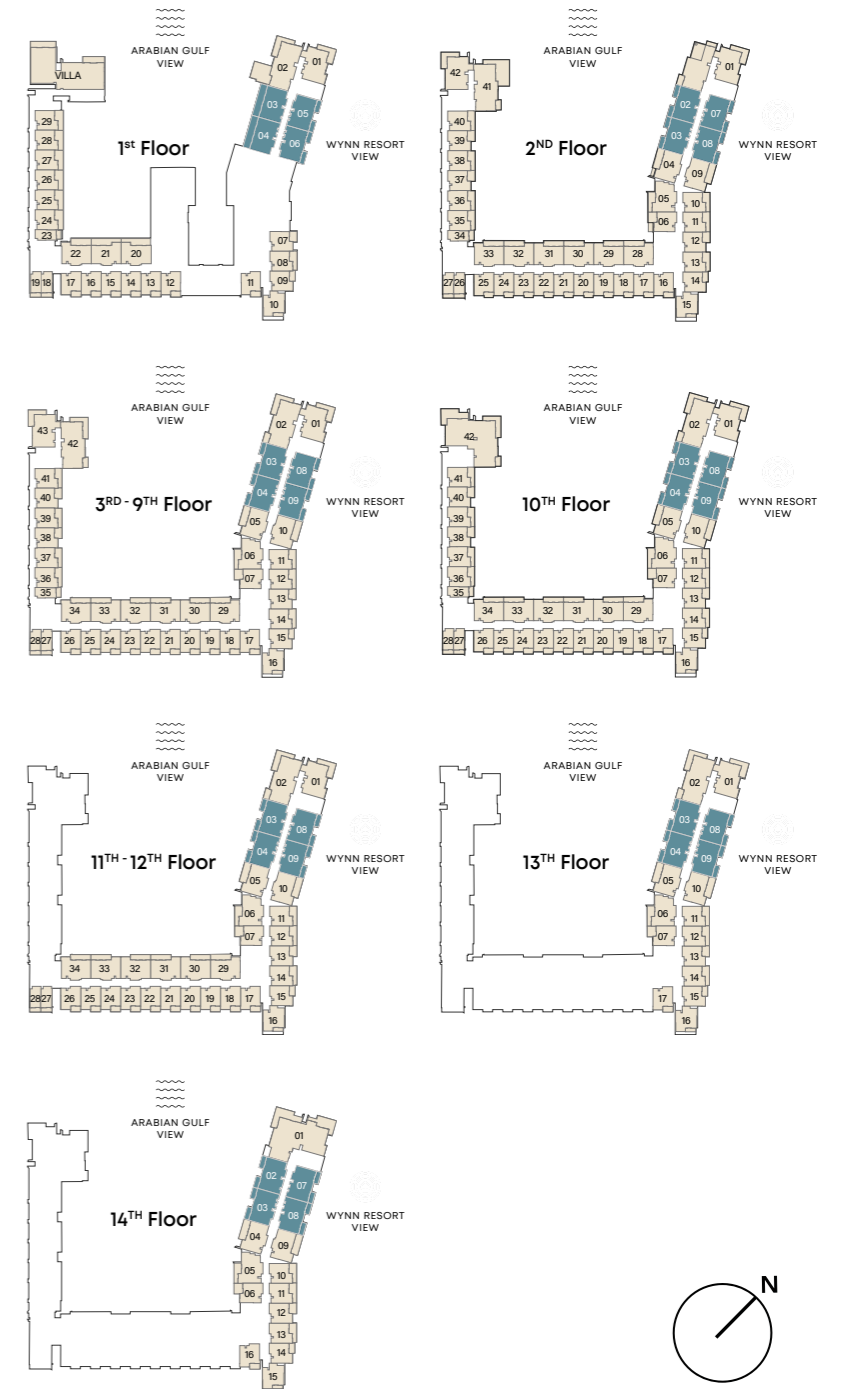

2-BEDROOM

TYPE D



INTERNAL LIVING AREA	1143.88 SQ. FT
OUTDOOR LIVING AREA	237.88 SQ. FT
TOTAL LIVING AREA	1381.76 SQ. FT

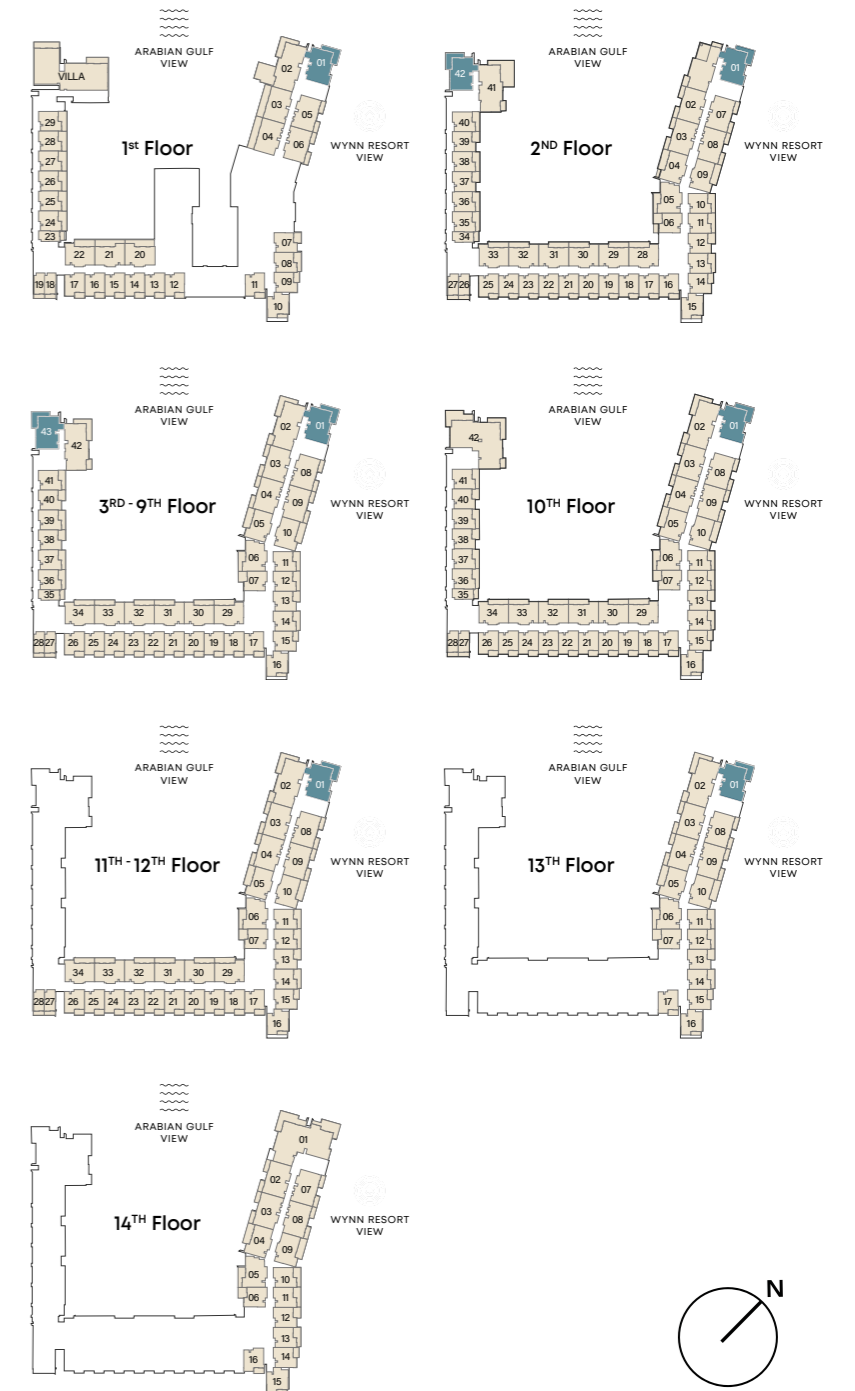

3-BEDROOM

TYPE A



INTERNAL LIVING AREA	1549.57 SQ. FT
OUTDOOR LIVING AREA	356.93 SQ. FT
TOTAL LIVING AREA	1906.53 SQ. FT

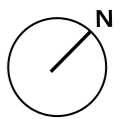
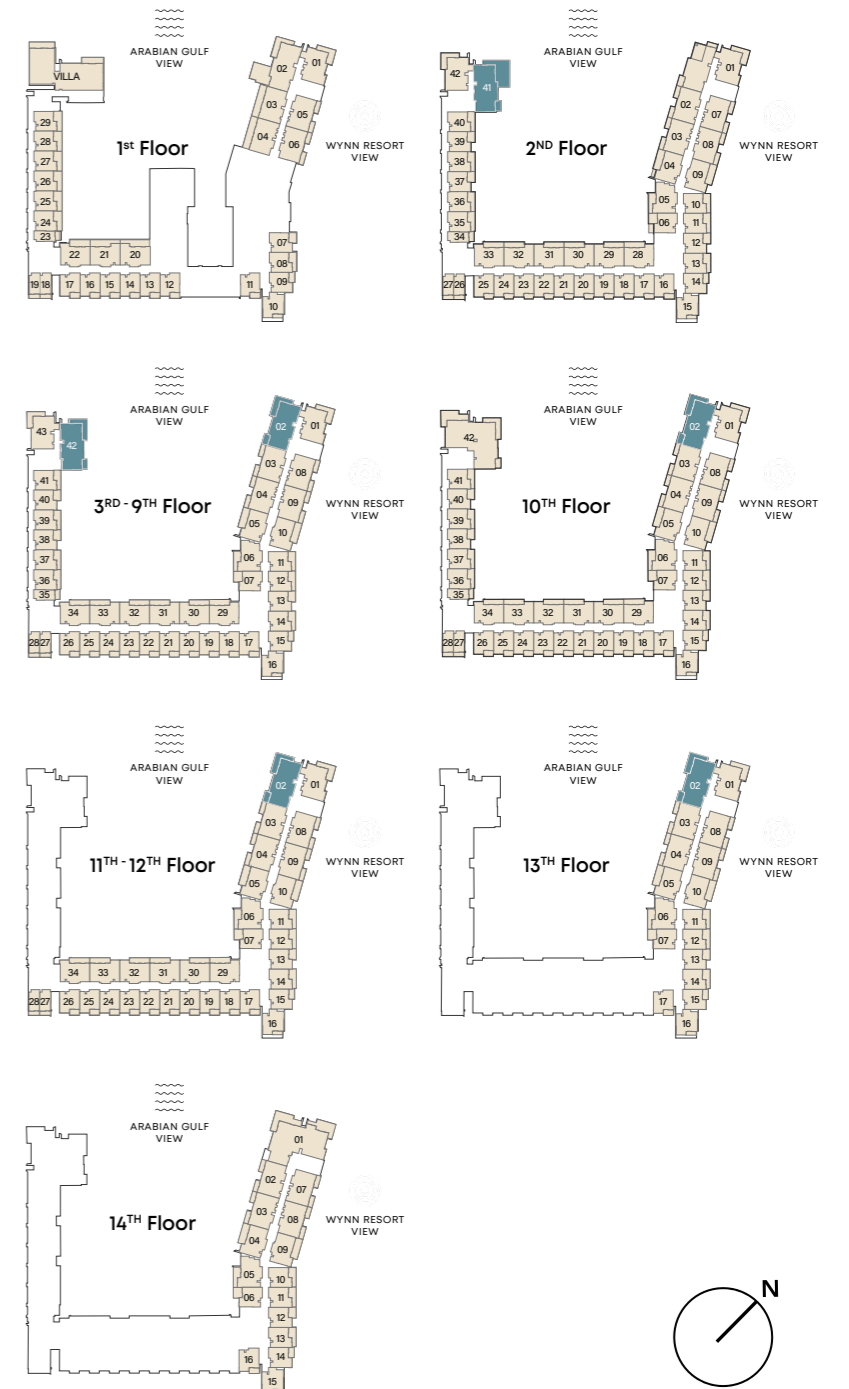

3-BEDROOM

DUPLEX

INTERNAL LIVING AREA	2821.22 SQ. FT
OUTDOOR LIVING AREA	957.34 SQ. FT
TOTAL LIVING AREA	3778.56 SQ. FT



LOWER LEVEL

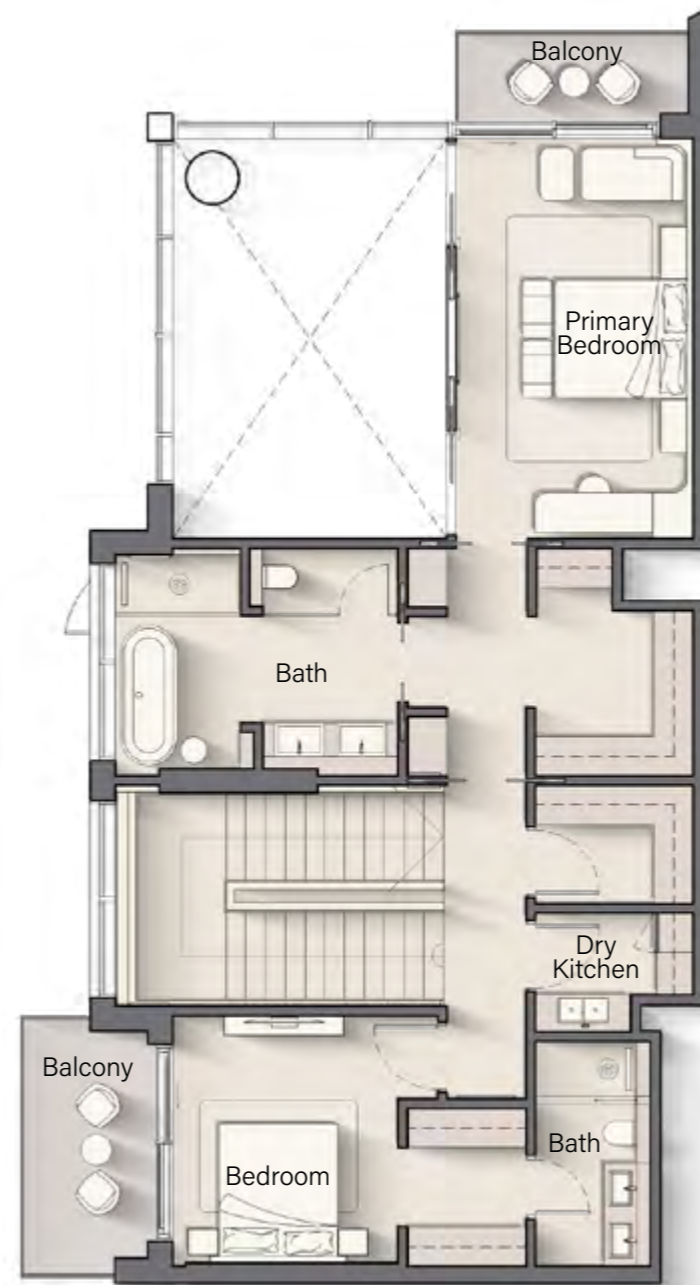

UPPER LEVEL

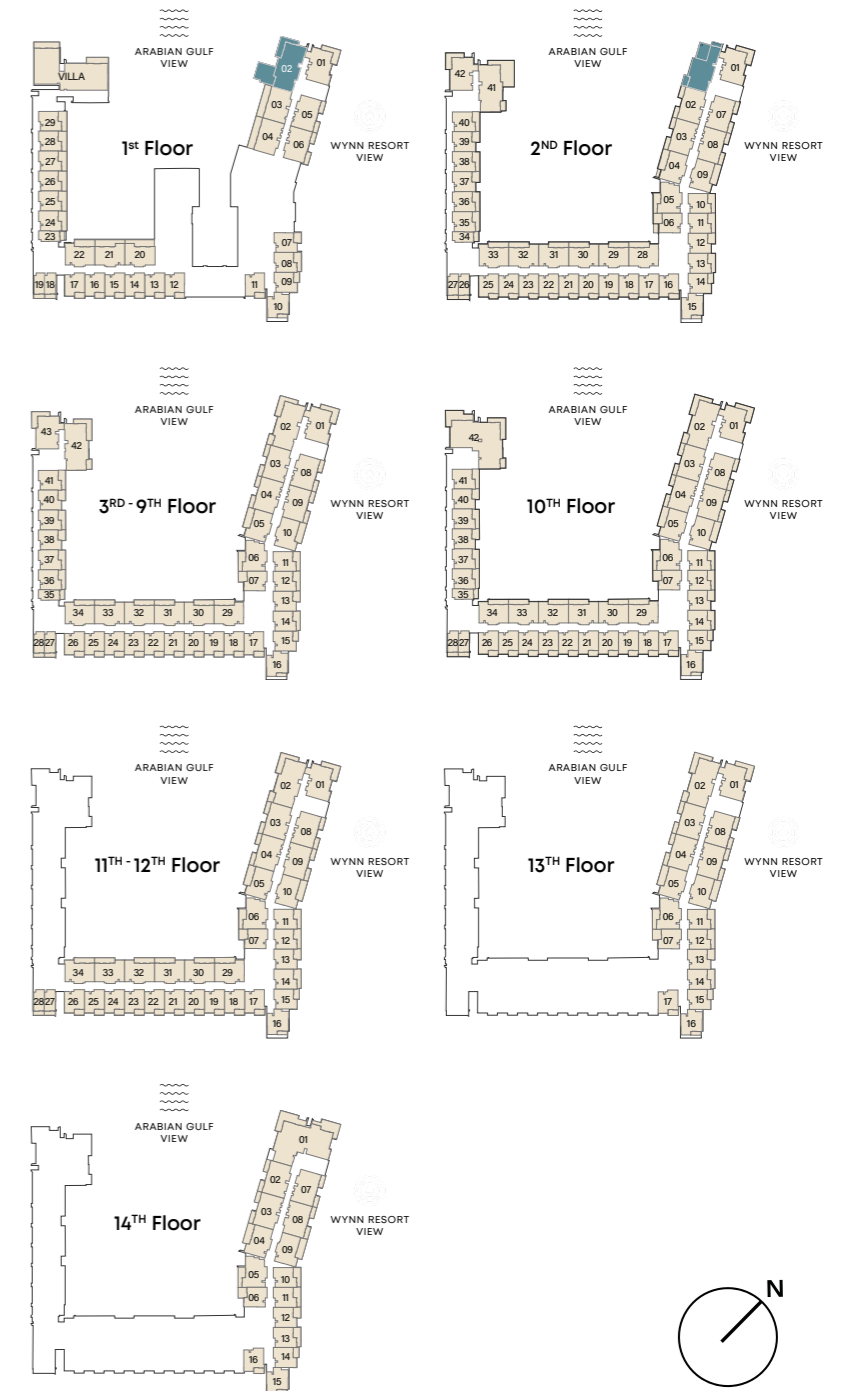

PENTHOUSE

TYPE A



INTERNAL LIVING AREA	2771.81 SQ. FT
OUTDOOR LIVING AREA	778.55 SQ. FT
TOTAL LIVING AREA	3550.37 SQ. FT

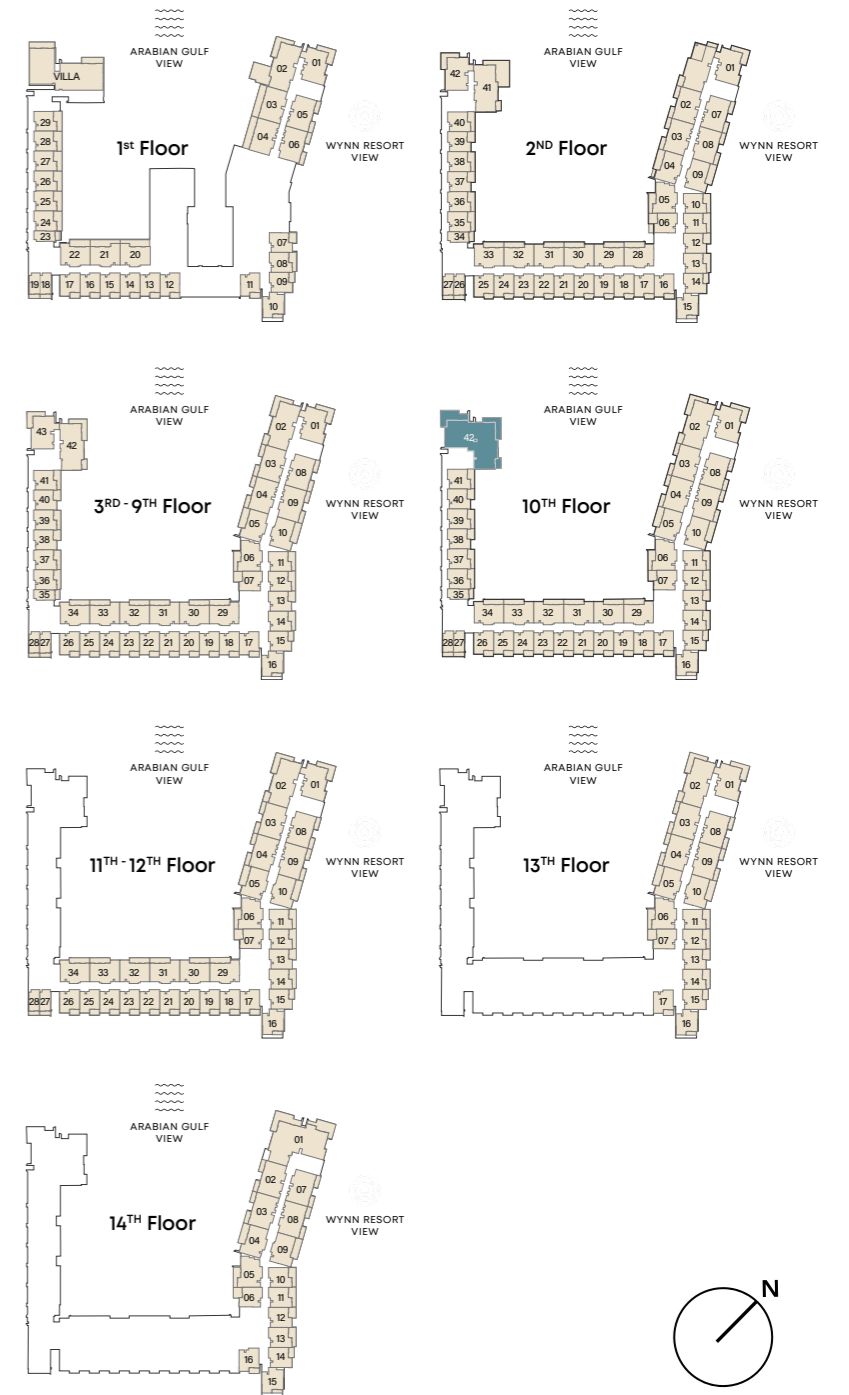

PENTHOUSE

TYPE B



INTERNAL LIVING AREA	2648.57 SQ. FT
OUTDOOR LIVING AREA	810.52 SQ. FT
TOTAL LIVING AREA	3459.09 SQ. FT

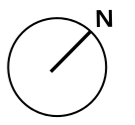
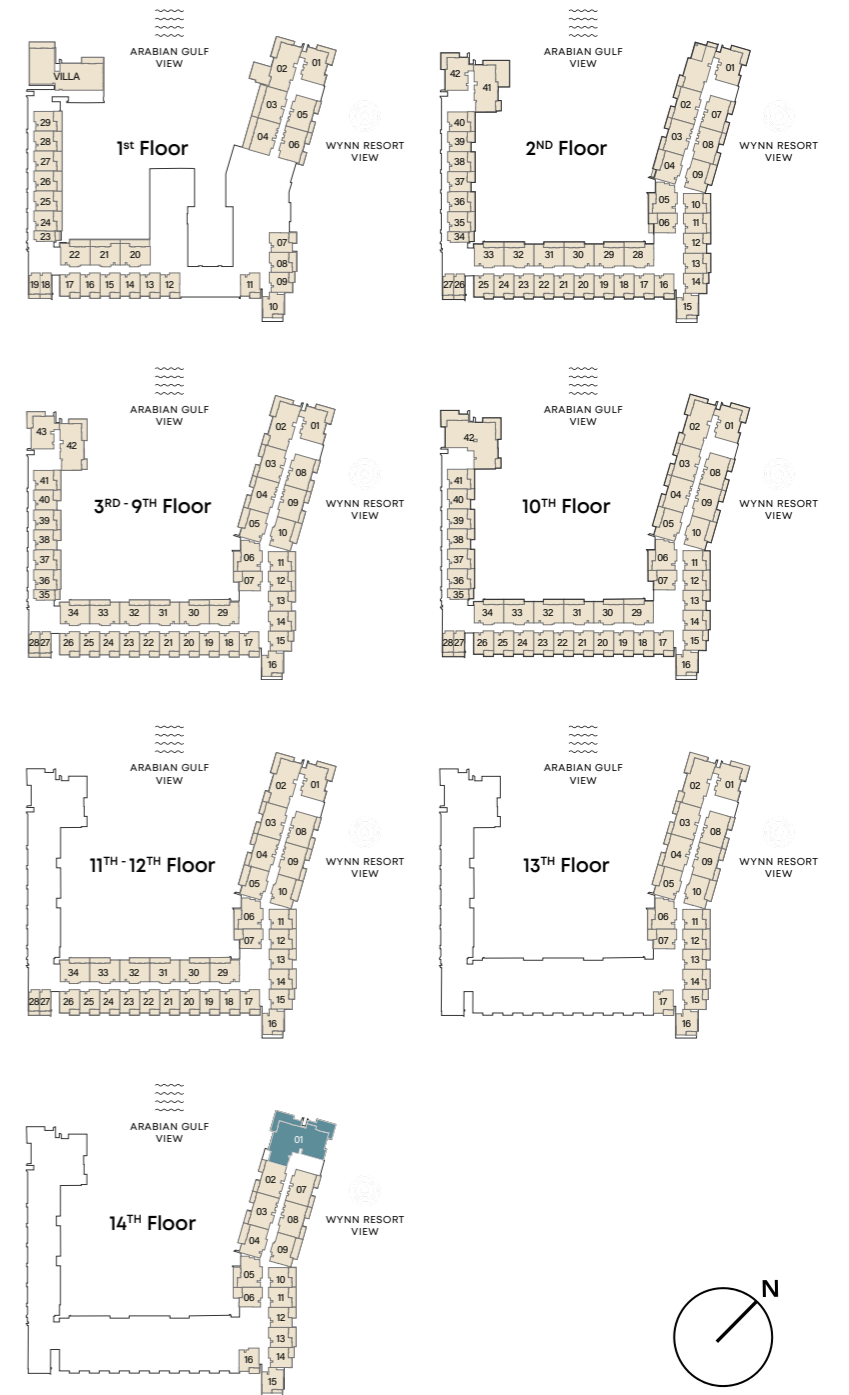

THE VILLA

B + G + 1

LOWER LEVEL

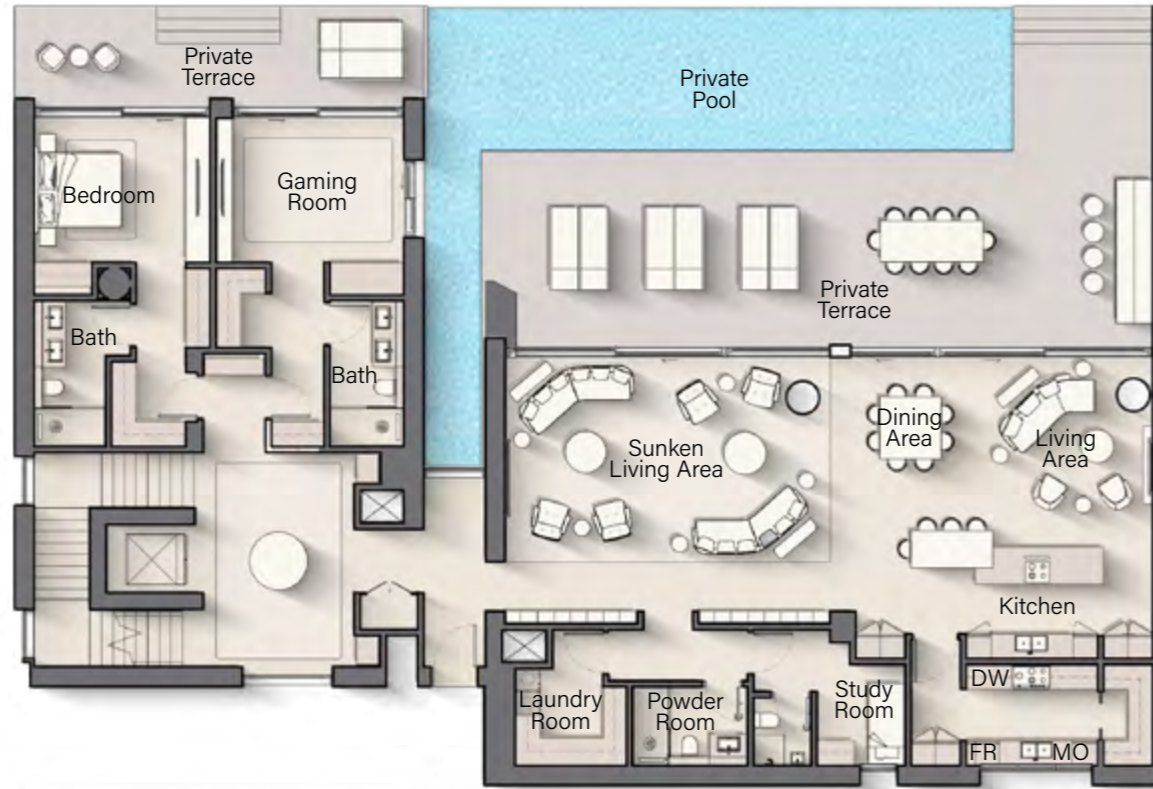

UPPER LEVEL

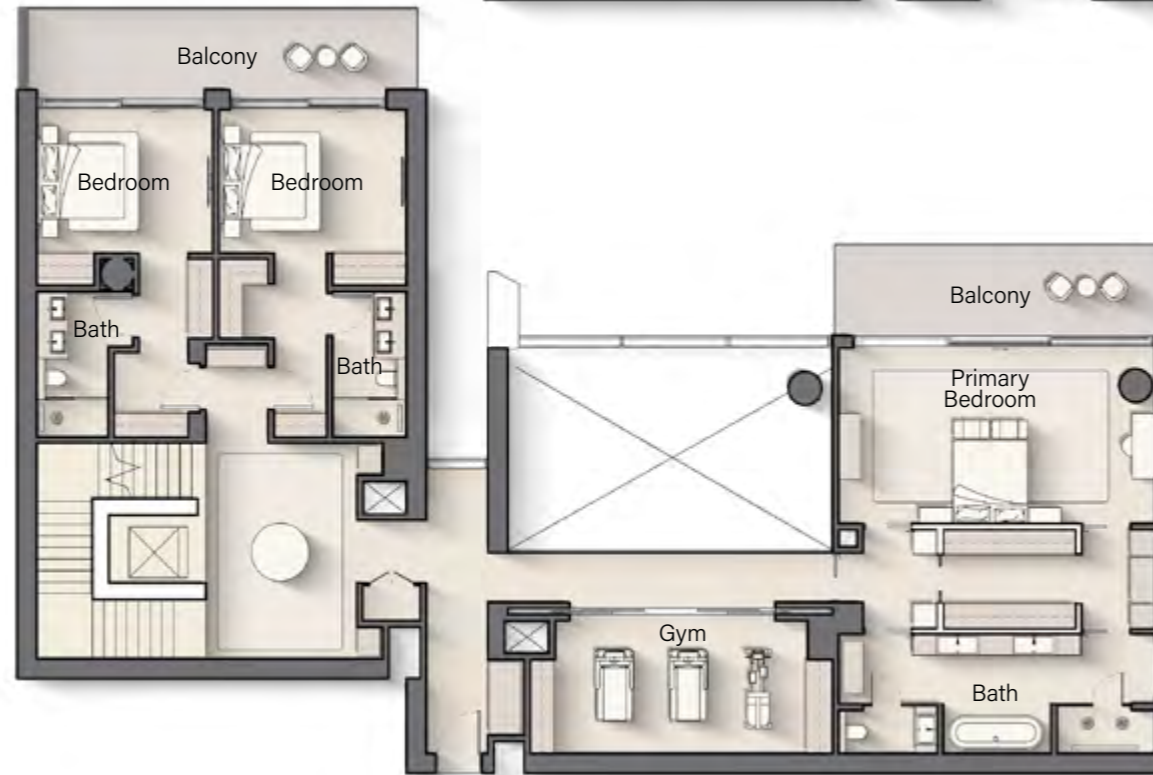

INTERNAL LIVING AREA	6392.15 SQ. FT
OUTDOOR LIVING AREA	2281.63 SQ. FT
TOTAL LIVING AREA	8673.77 SQ. FT

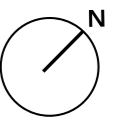
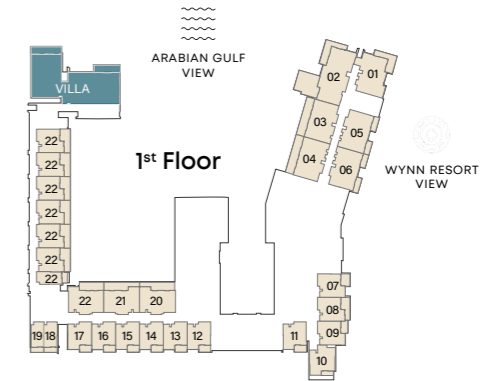
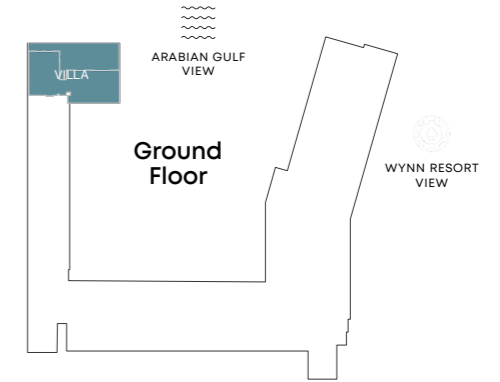

PAYMENT PLAN

20%

AT THE TIME OF BOOKING
+ AED 3,000 RERA
REGISTRATION FEE

10%

90 DAYS AFTER THE
RESERVATION DATE

10%

180 DAYS AFTER THE
RESERVATION DATE

5%

ON COMPLETION OF
20% CONSTRUCTION
OF THE PROJECT

5%

ON COMPLETION OF
30% CONSTRUCTION
OF THE PROJECT

5%

ON COMPLETION OF
40% CONSTRUCTION
OF THE PROJECT

5%

ON COMPLETION OF
50% CONSTRUCTION
OF THE PROJECT

40%

ON COMPLETION*

* plus 4% upon completion and this amount is earmarked specifically
to cover expenses related to the title deed registration process

PROJECT INTERACTIVE APP

To navigate the project interactive web page of Playa Del Sol, click **HERE** or scan the QR code:



SCAN THE QR CODE





800 8288
info@ellingtongroup.com

ELLINGTONPROPERTIES.AE

The renderings and visualizations contained in this brochure are provided for illustrative and marketing purposes. While the information provided is believed to be accurate and reliable at the time of printing, only the information contained in the final Sales and Purchase Agreement will have any legal effect.